

AVA
VOLUMES

CATALOG **2023**



The logo consists of the letters 'AVA' in a bold, stylized, black font with a jagged, mountain-like top edge. Below it, the word 'VOLUMES' is written in a clean, black, sans-serif font.

AVA
VOLUMES

The background features a complex geometric pattern of thin black lines forming various triangles and polygons. Three solid grey circles are scattered across the page: one in the top right, one in the middle left, and one in the middle right.

Handmade plywood climbing volumes

A passion for woodworking and climbing combined

About us... AVA was founded in 2020 from the desire to combine two passions - climbing and woodworking. We started as a small garage company in Warsaw (Poland) with just a few models of volumes tested at one of the local climbing gyms. Today you can climb AVA volumes on walls all over Europe, but also in the USA and Asia. In our catalog you will find over 140 models of various shapes and sizes with which you can create routes for beginner climbers as well as set the final boulder of a competition for professional climbers.

We are a group of designers, manufacturers, routsetters and above all climbers. We take care of our volumes at every step - from the concept of the shape through the design and production process to the pleasure of climbing on the wall. With our very own workshop in the heart of Poland we can provide you with the highest quality product.

We keep growing, always connected with the trends of the global climbing market.



Content

// CLASSIC

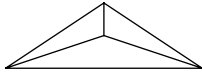

Delta
8

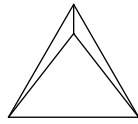

Fresco 30°
8



Concord
9

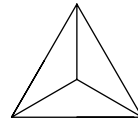

Avalon
9

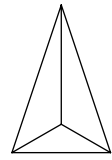

Lancia
10

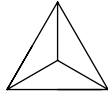

Classica
10

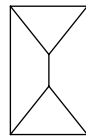

Amon
11

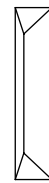

Parapetto
11

// ASYMMETRIC



Boomerang
14



Leon
14

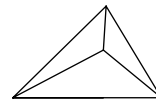

Austin
15

// TWINS-ONE SIDE 90°

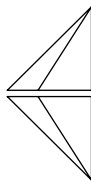

Half Chava
18

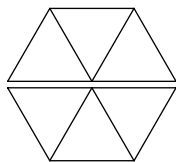

Half Circo
18

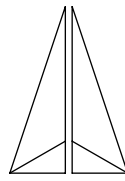

Half Lancia
19

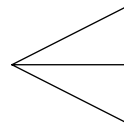

Flat 90°
19

Content

// FLAT

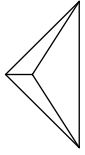

Chava
22

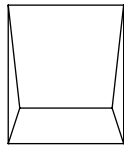

Rampa Wide
22

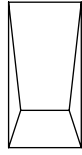

Rampa
23

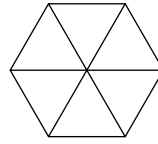

Circo
23

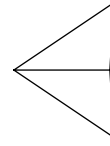

Flat 80°
24

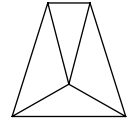

Anton
24

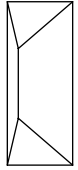

Gobba
25

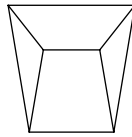

Mago
25



Splash
26

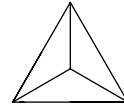

Avalon Flat
26

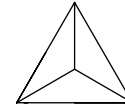

Avalon Superflat
27

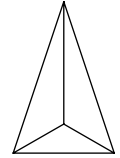

Lancia Flat
27

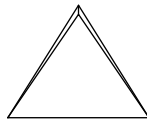

Fresco 10°
28

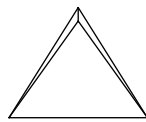

Fresco 20°
28

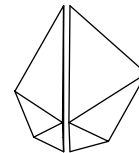

Fratelli 1
29

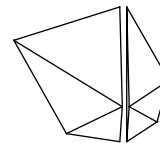

Fratelli 2
29

// PINCHES



Cuneo
32



Cuneo lungo
32

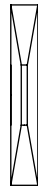

Asteca
33

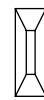

Tufa
33



French Fries
34

// GAMMA



Gamma 3
37

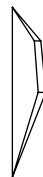

Large Gamma 3
37



Gamma 4
38

// TECHNICAL INFORMATION



// CLASSIC

Delta	8
Fresco	8
Concord	9
Avalon	9
Lancia	10
Classica	10
Amon	11
Parapetto	11

Delta

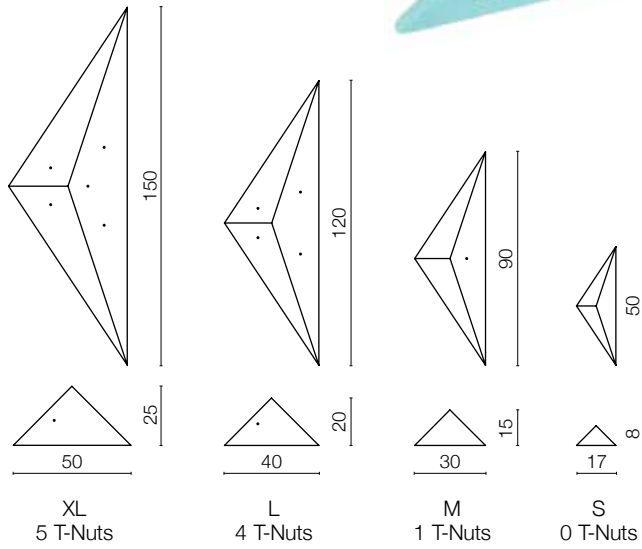
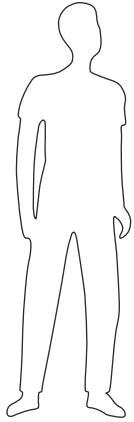

Fresco 30°

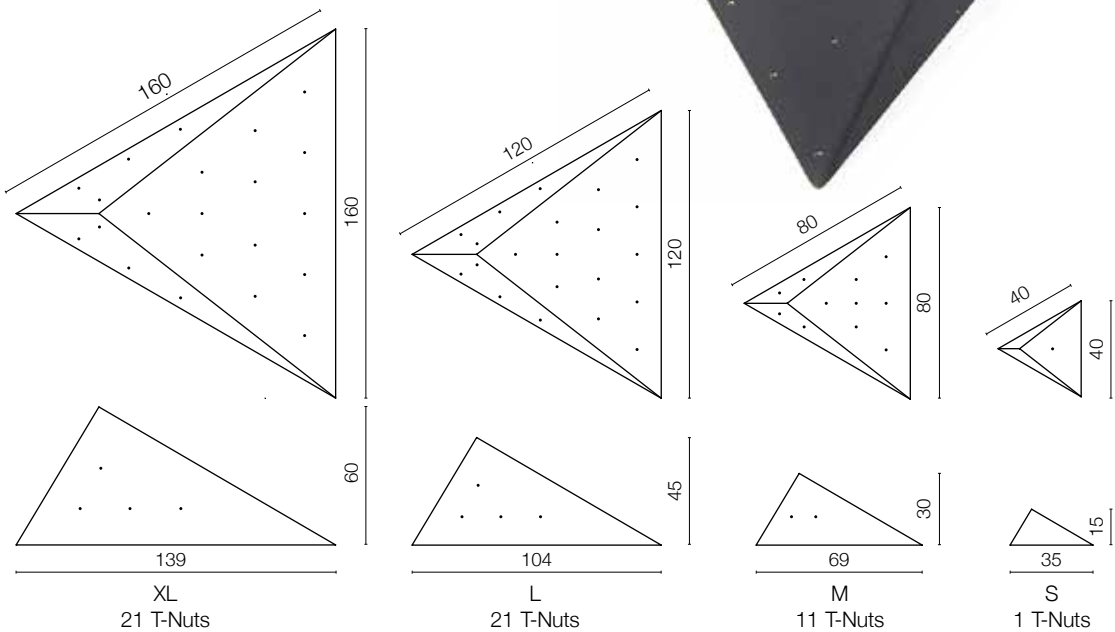
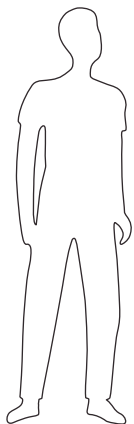

Concord

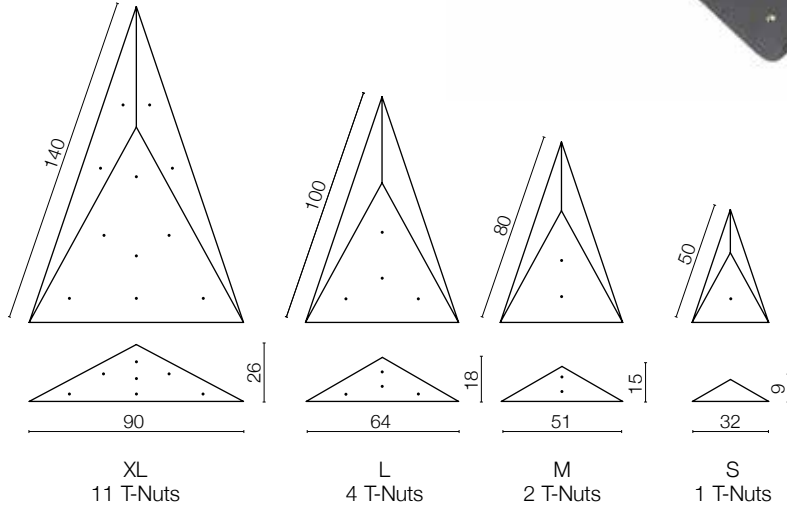
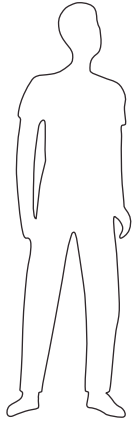

Avalon

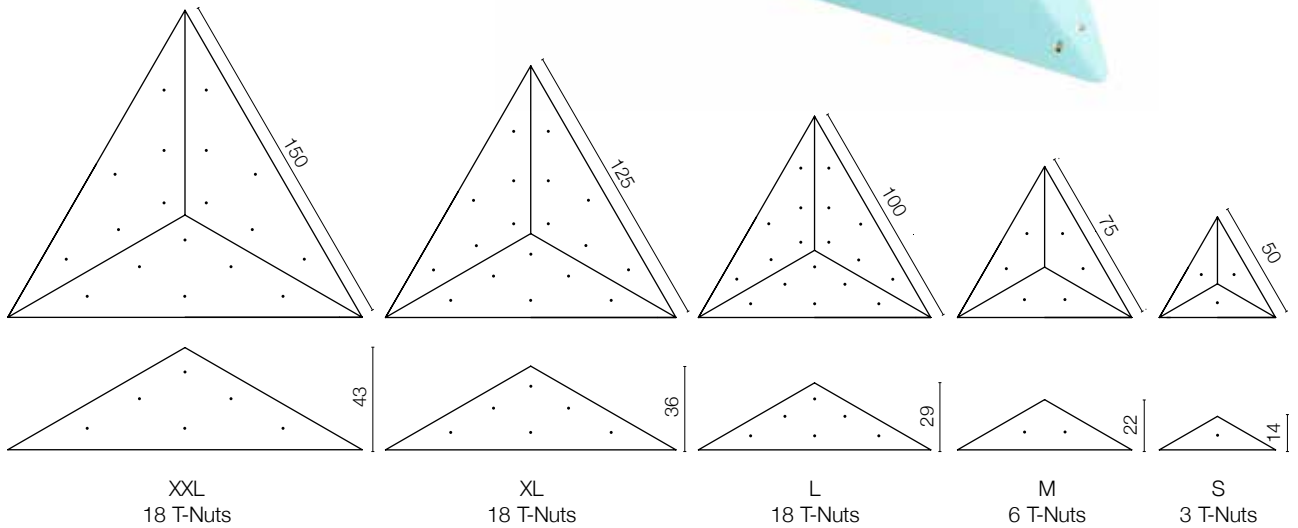
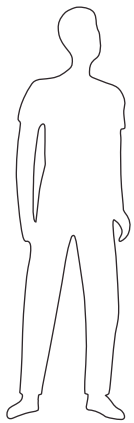

Lancia

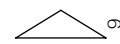
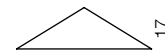
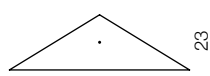
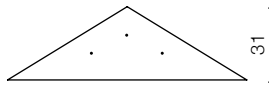
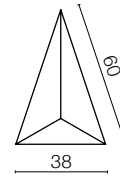
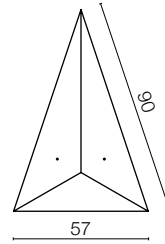
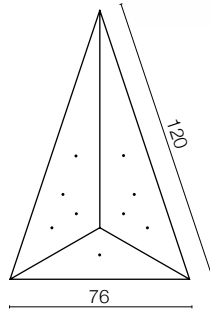
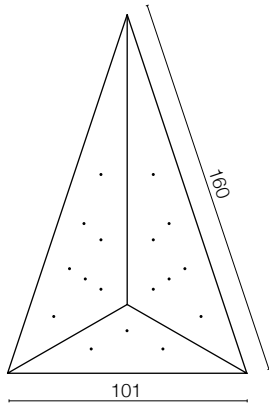

XL
17 T-Nuts

L
9 T-Nuts

M
2 T-Nuts

S
0 T-Nuts

// CLASSIC

10

Classica

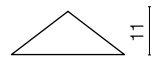
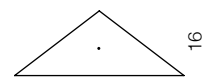
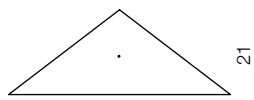
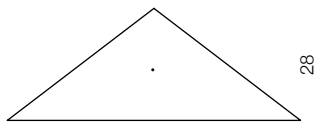
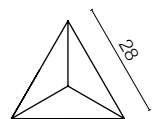
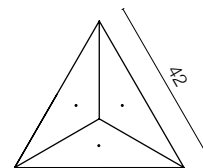
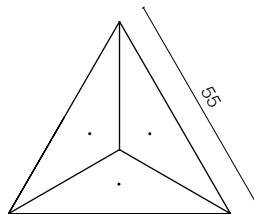
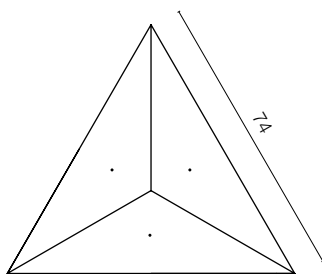
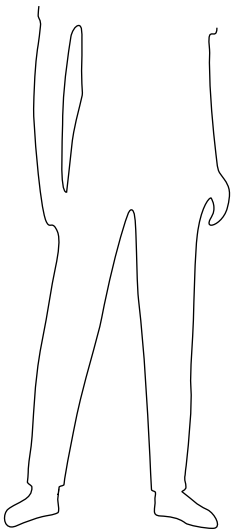

XL
3 T-Nuts

L
3 T-Nuts

M
3 T-Nuts

S
0 T-Nuts

Amon

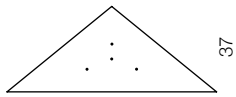
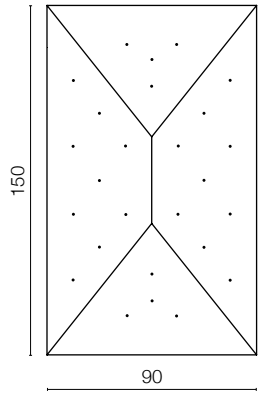
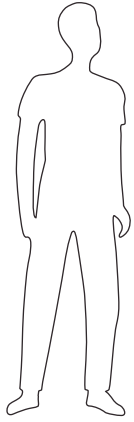

XXL
26 T-Nuts

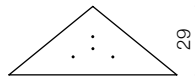
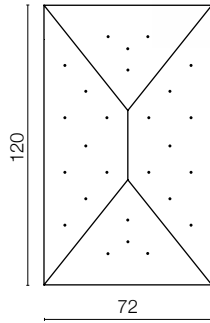

XL
26 T-Nuts

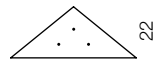
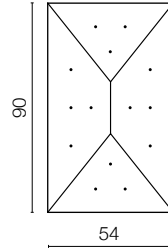

L
14 T-Nuts

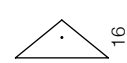
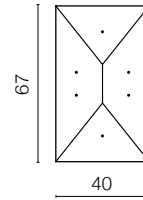

M
6 T-Nuts

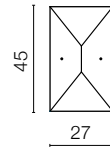

S
2 T-Nuts

Parapetto

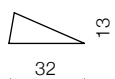
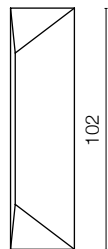
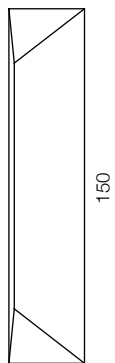
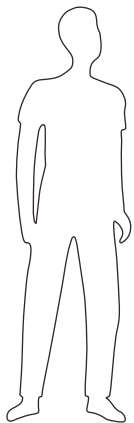

80° B

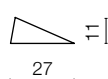

80° A

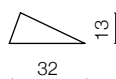
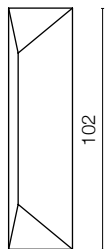
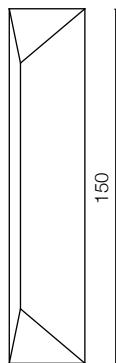

70° B

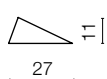

70° A

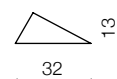
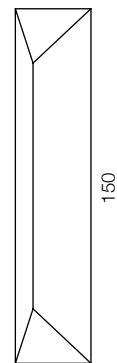

60° B

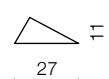

60° A



// ASYMMETRIC

Boomerang	14
Leon	14
Austin	15

Boomerang

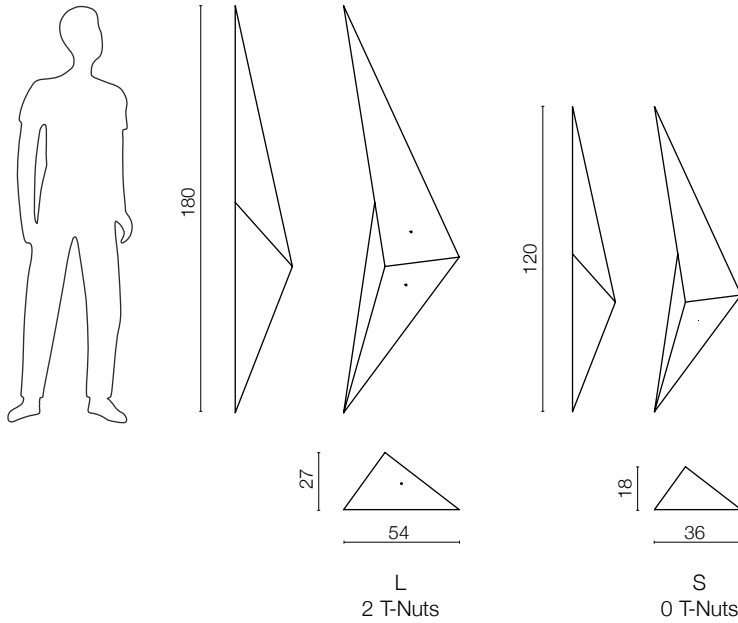

// ASYMMETRIC

14

Leon

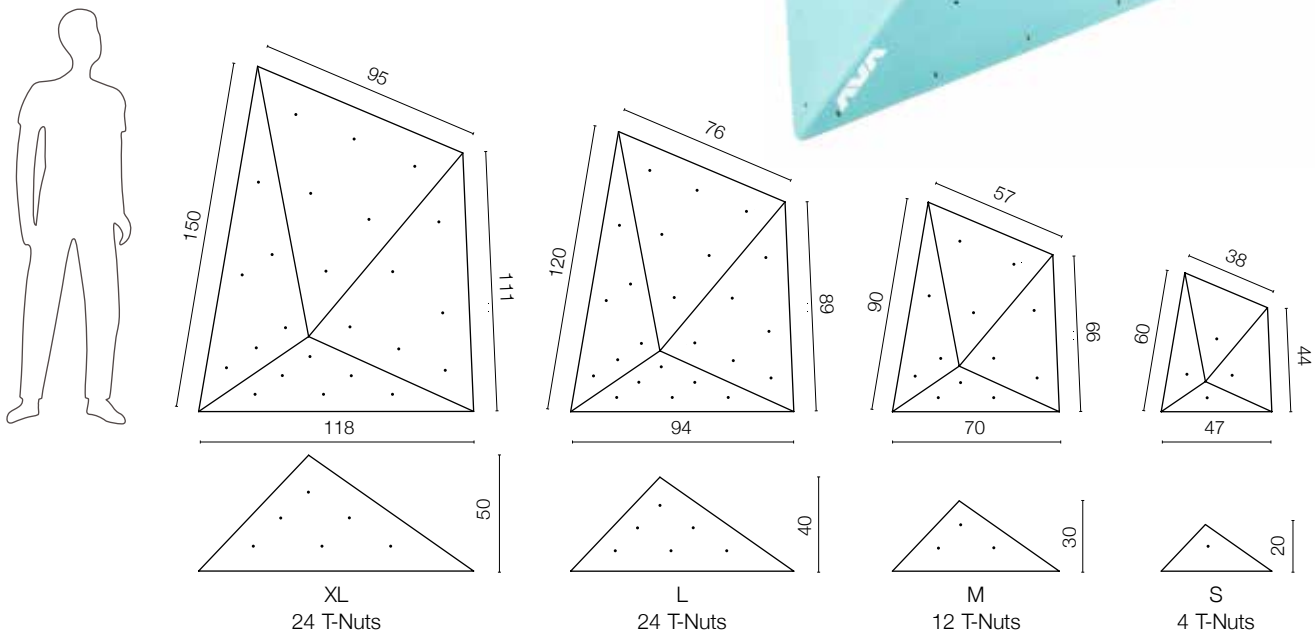

Austin

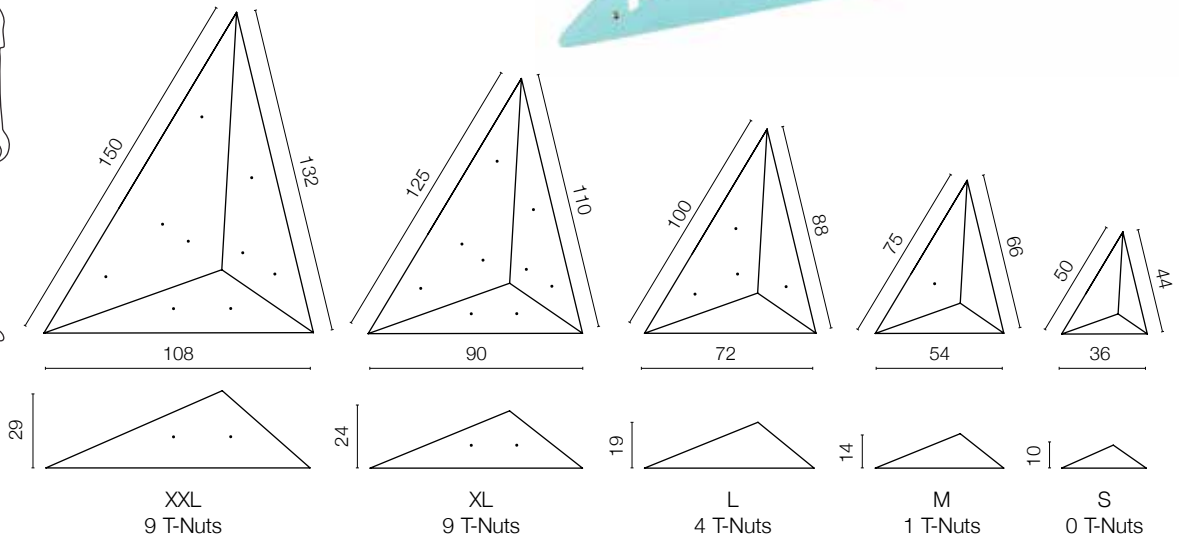
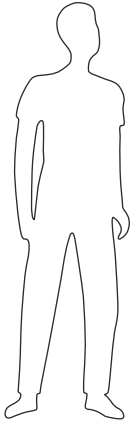



// TWINS-ONE SIDE 90°

Half Chava	18
Half Circo	18
Half Lancia	19
Flat 90°	19

Half Chava

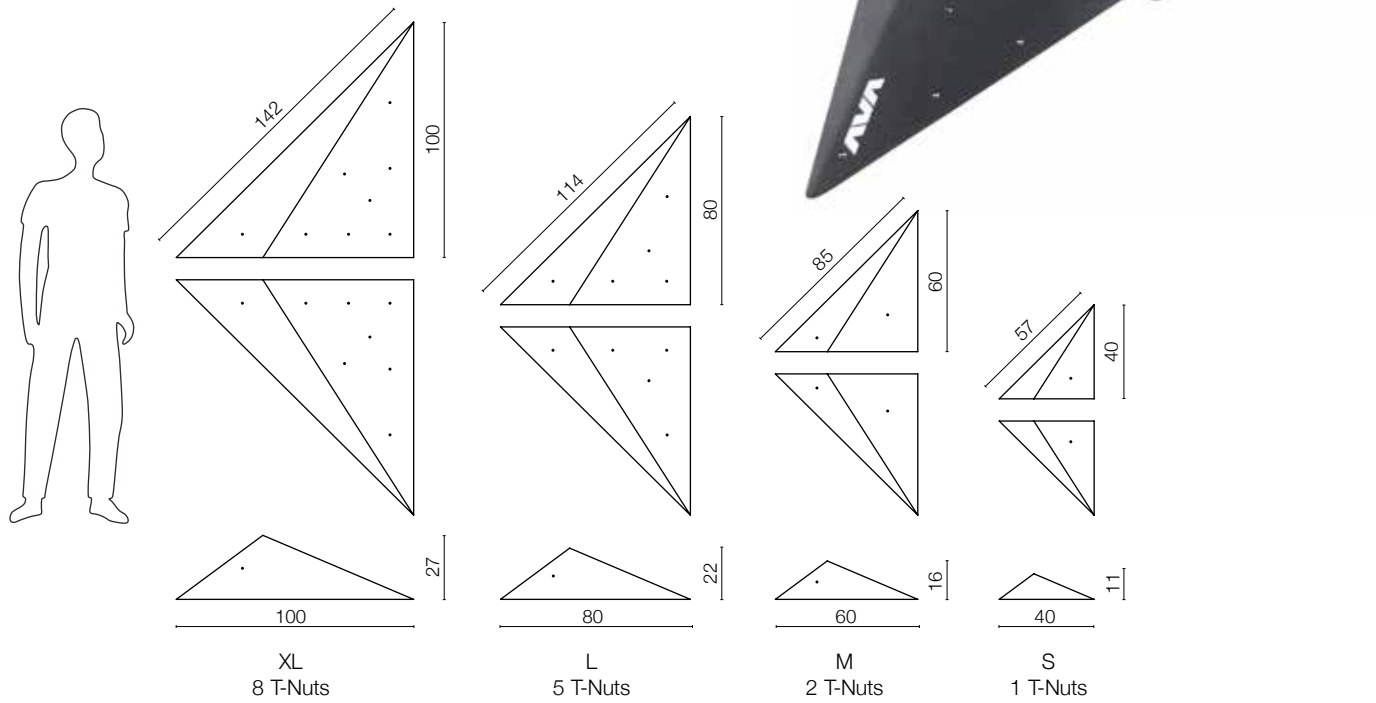

// TWINS - ONE SIDE 90°

Half Circo

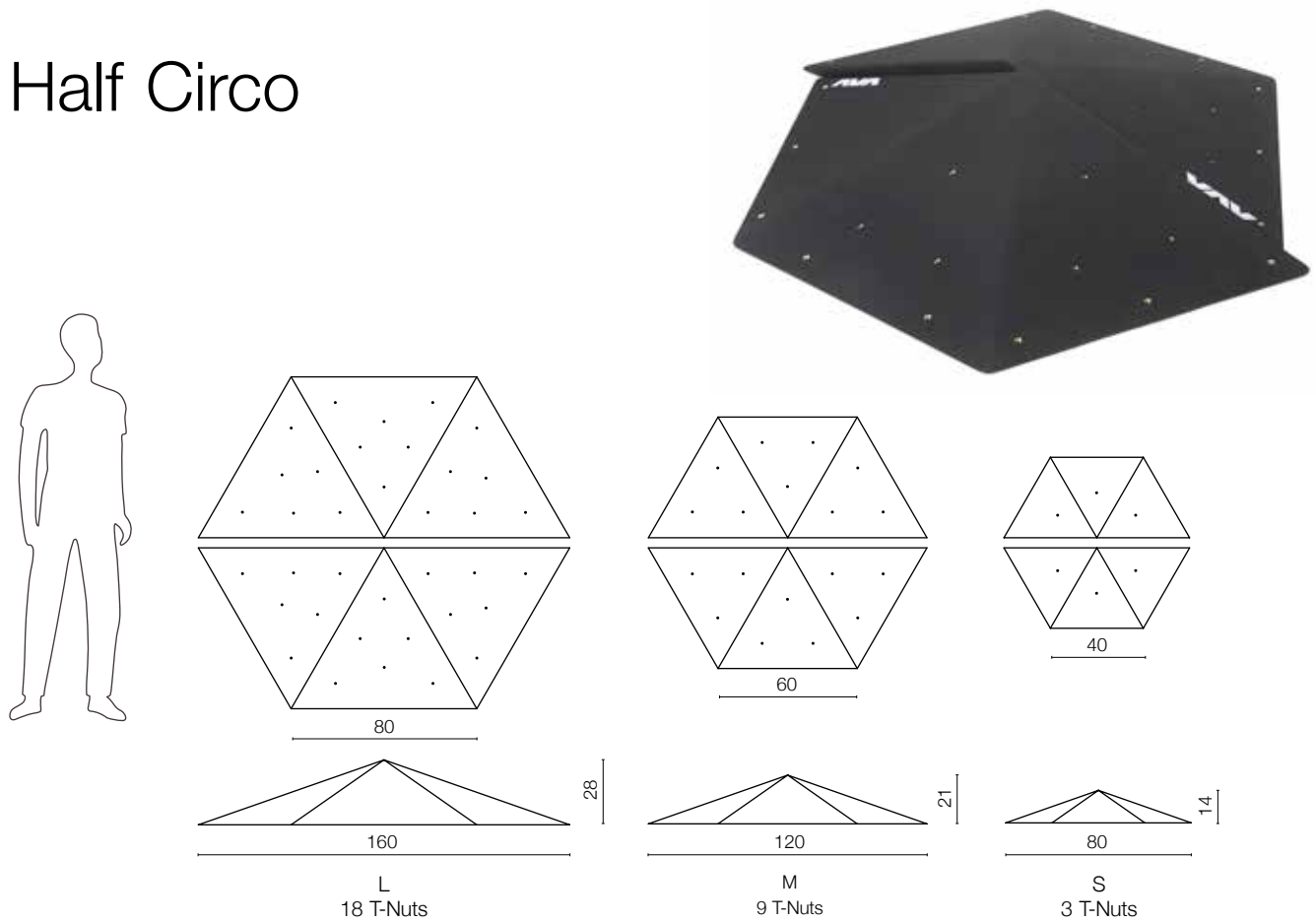

Half Lancia

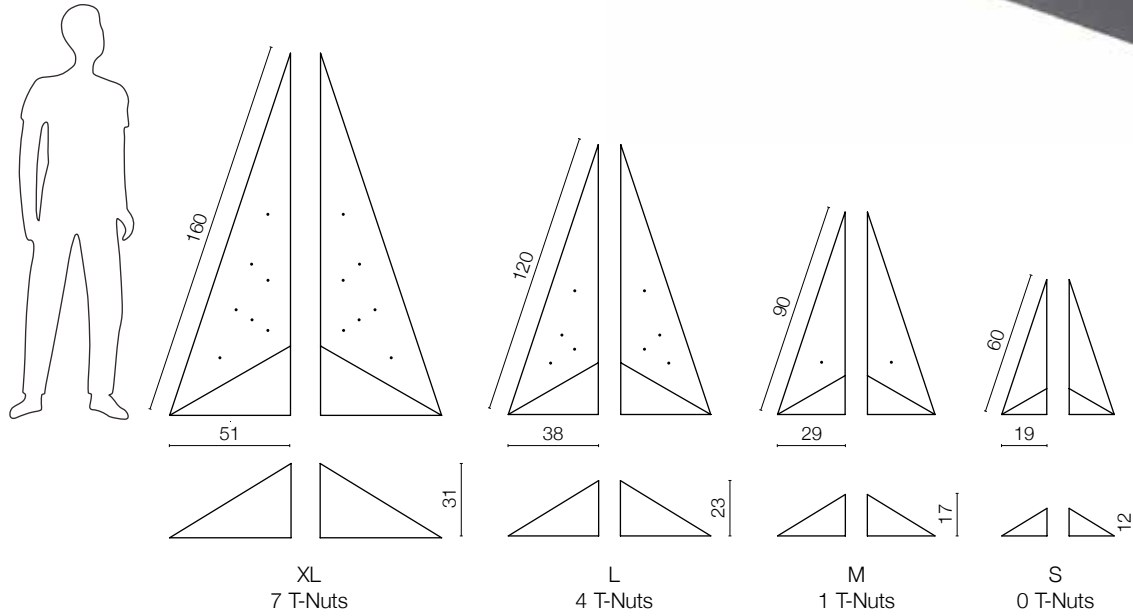

Flat 90°

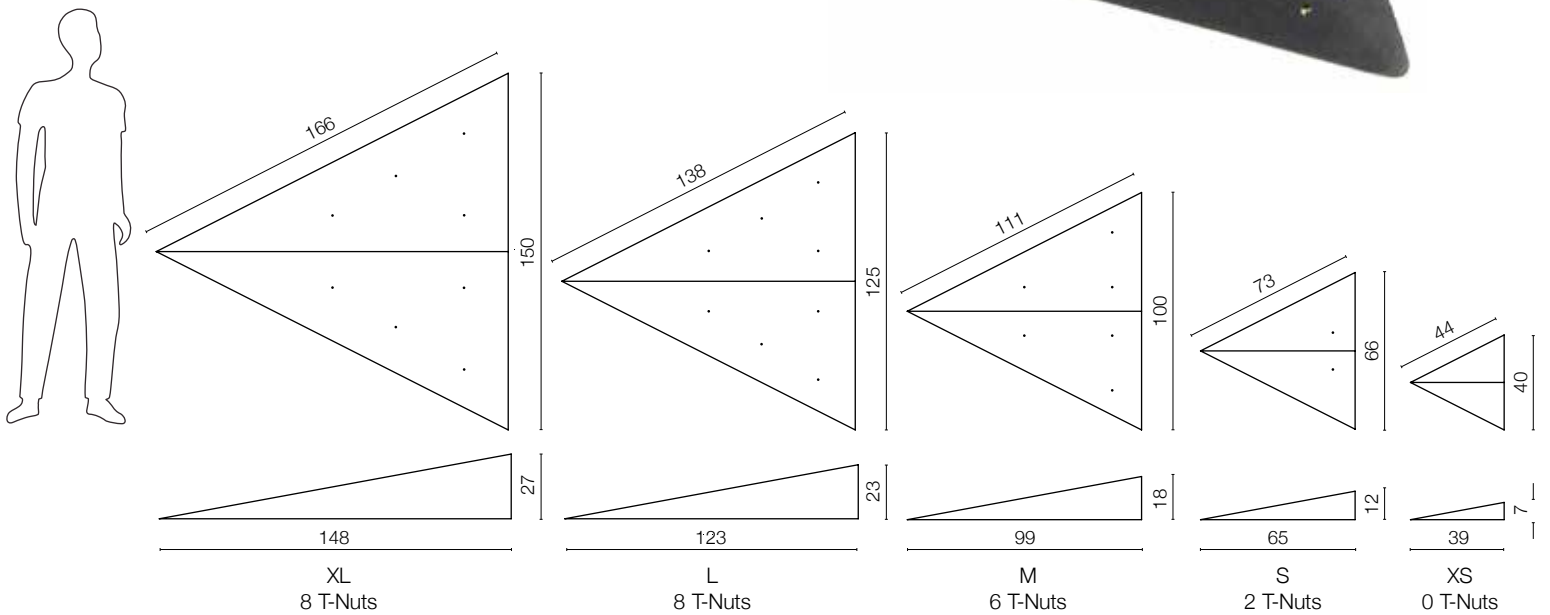



AVA
VOLUMES

AVA

AVA

AVA

AVA

// FLAT

Chava	22
Rampa Wide	22
Rampa	23
Circo	23
Flat 80°	24
Anton	24
Gobba	25
Mago	25
Splash	26
Avalon Flat	26
Avalon Superflat	27
Lancia Flat	27
Fresco 10°	28
Fresco 20°	28
Fratelli 1	29
Fratelli 2	29

Chava

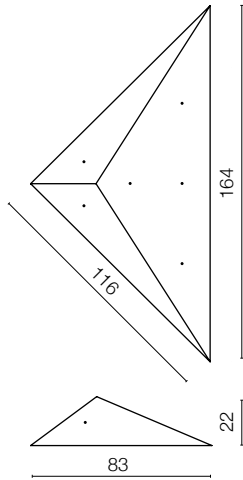
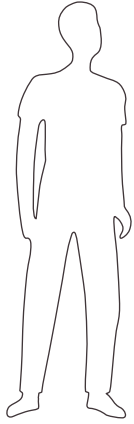

XL
6 T-Nuts

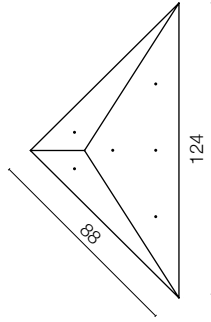

L
6 T-Nuts

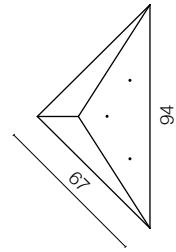

M
3 T-Nuts

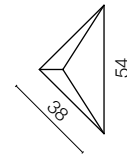

S
0 T-Nuts

// FLAT

22

Rampa Wide

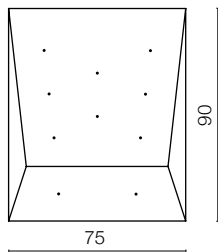

One Size
10 T-Nuts

Rampa

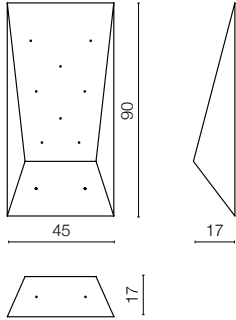
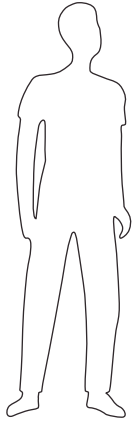

One Size
10 T-Nuts

Circo

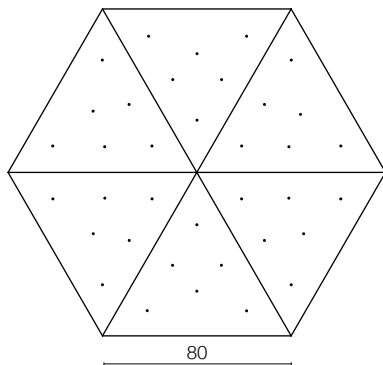

L
36 T-Nuts

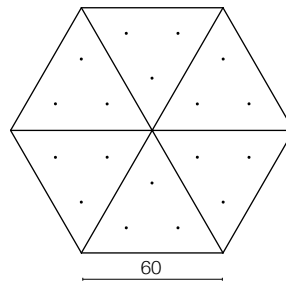

M
18 T-Nuts

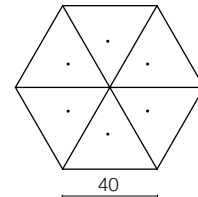

S
6 T-Nuts

Flat 80°

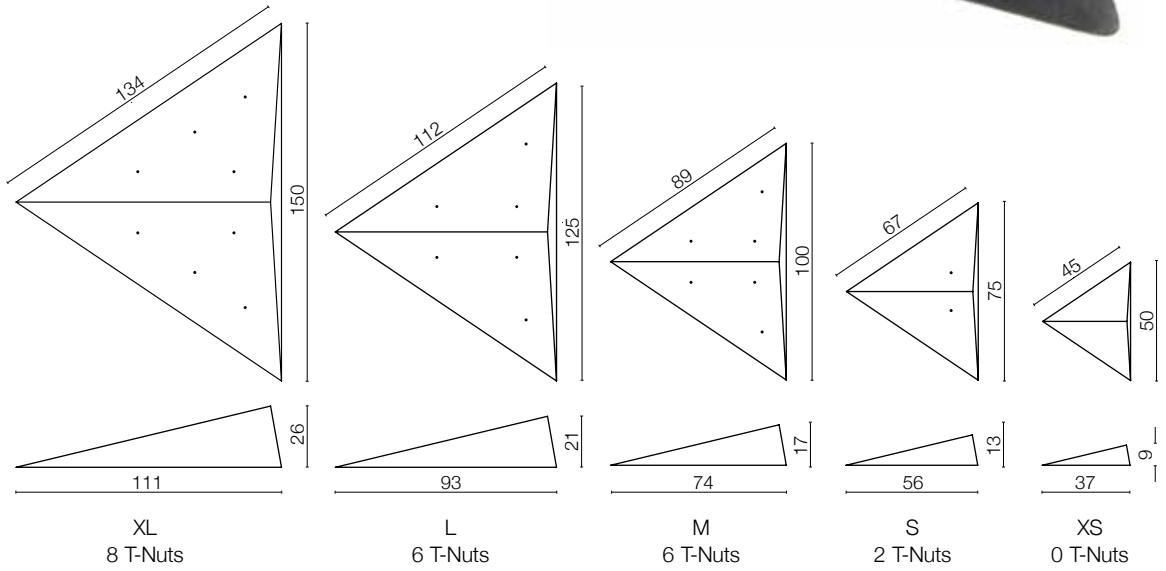
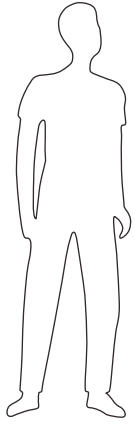

// FLAT

Anton

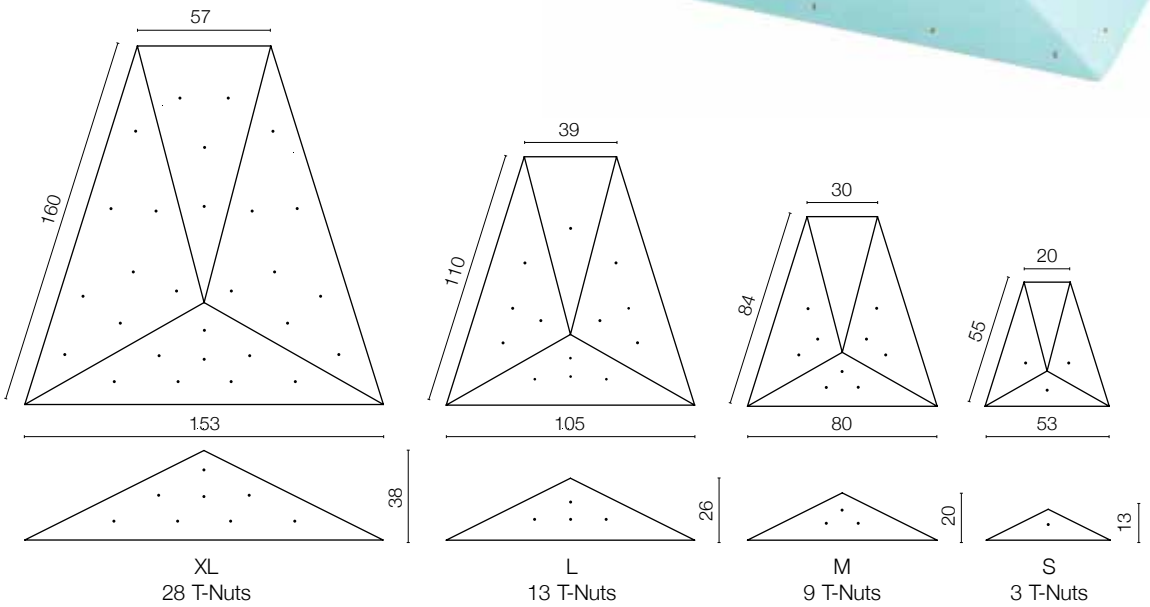
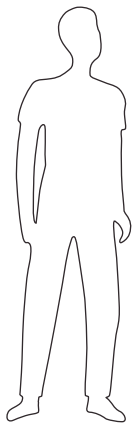

Gobba

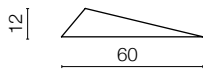
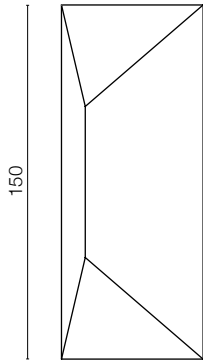
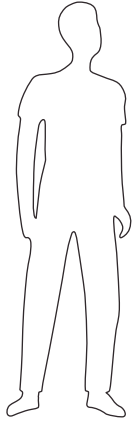

One Size
0 T-Nuts

Mago

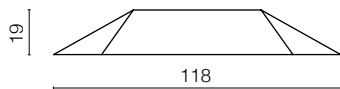
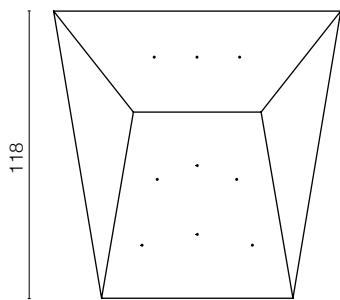
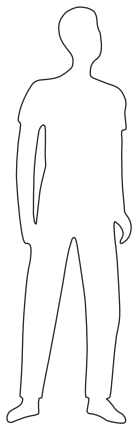

L
9 T-Nuts

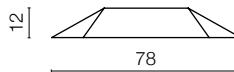
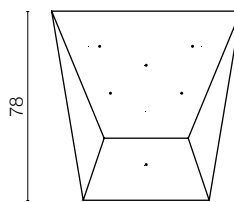

MB
6 T-Nuts

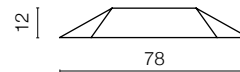
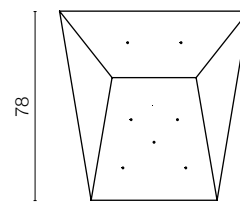

MA
7 T-Nuts

Splash

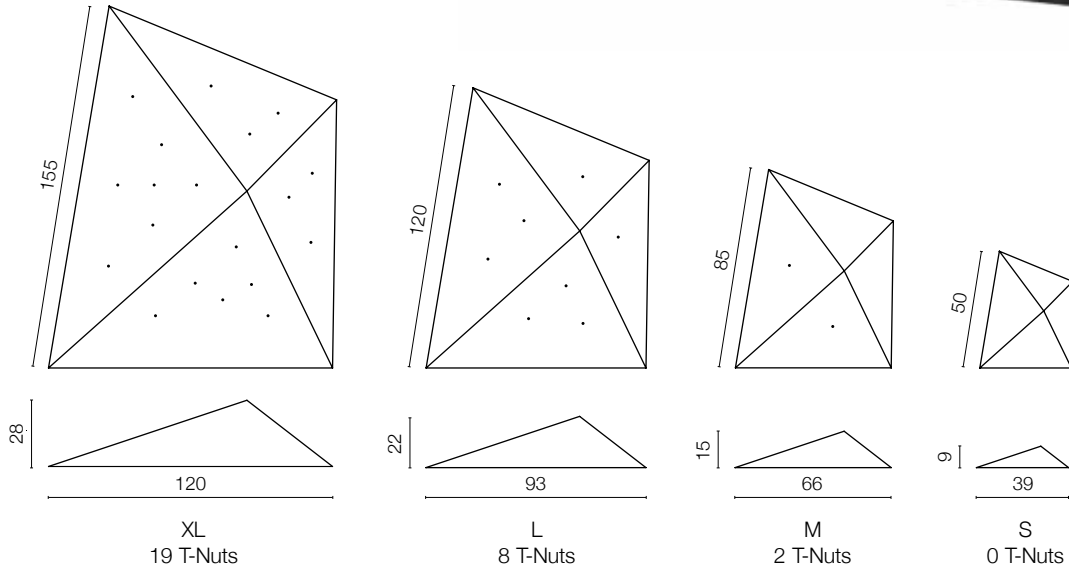
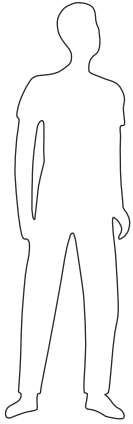

// FLAT

26

Avalon Flat

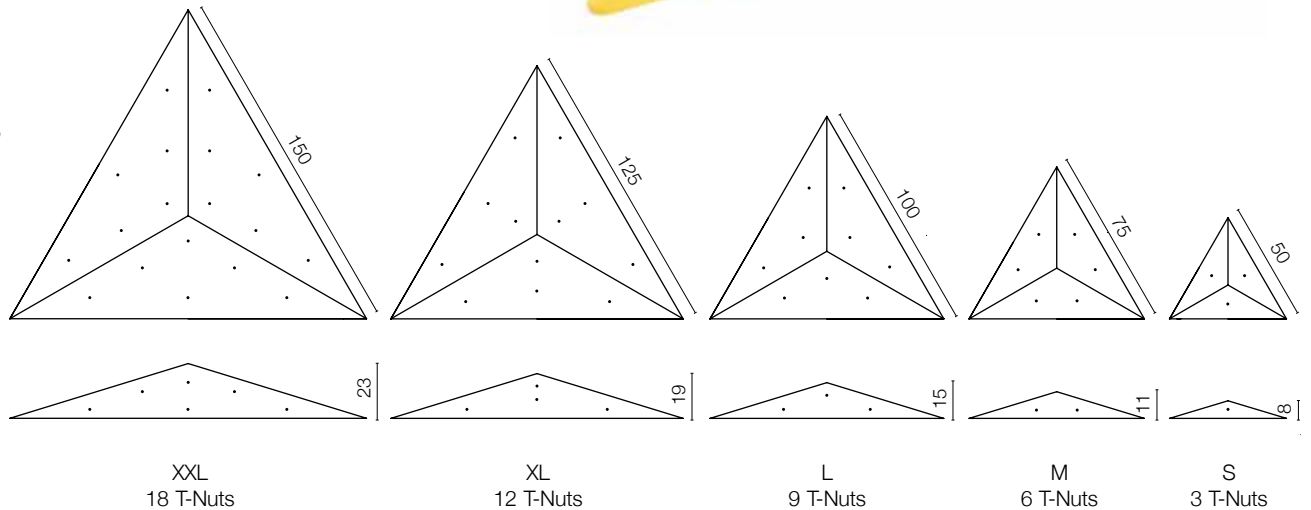

Avalon Superflat

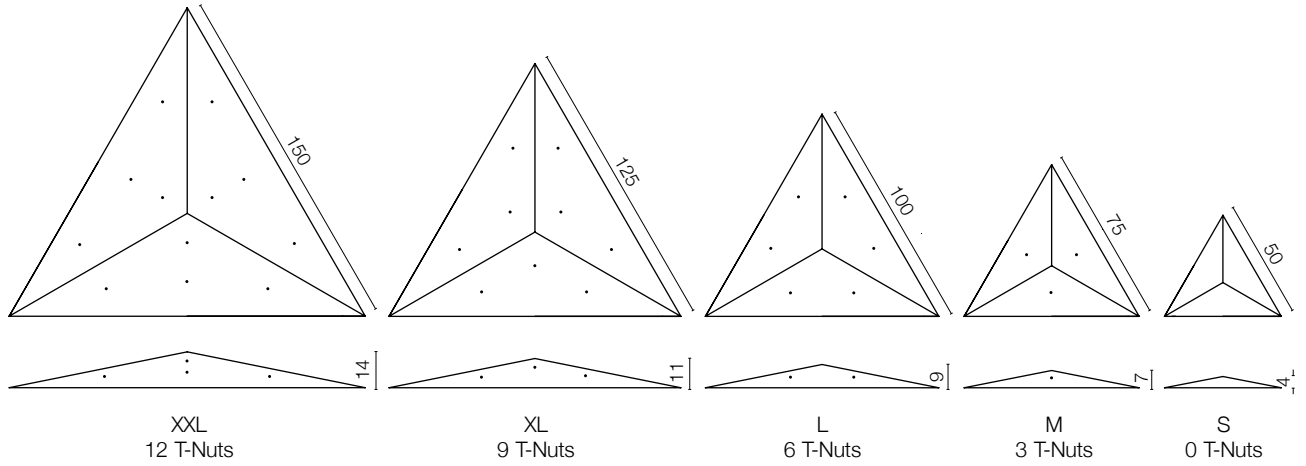
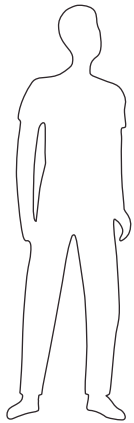

Lancia Flat

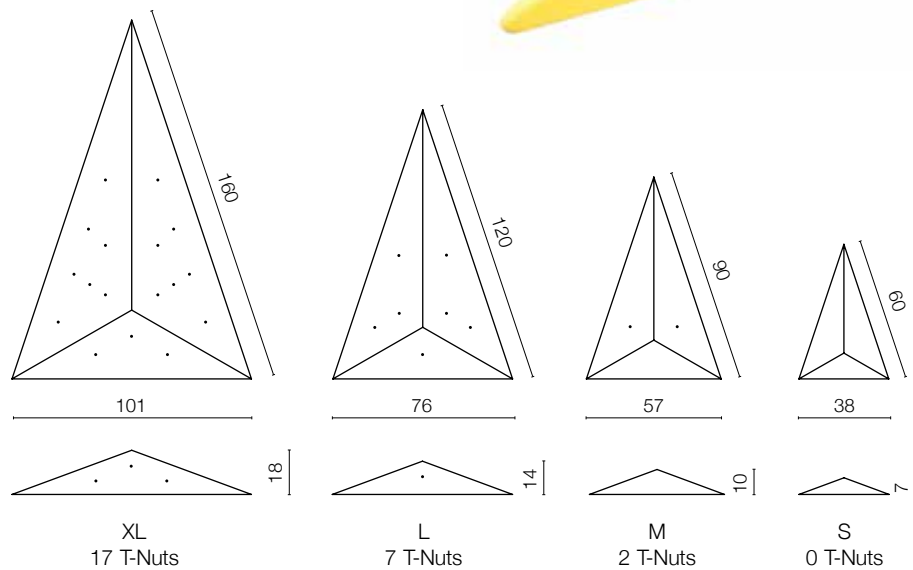
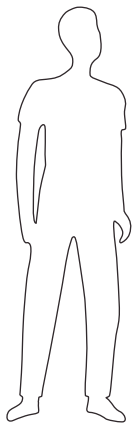

Fresco 10°

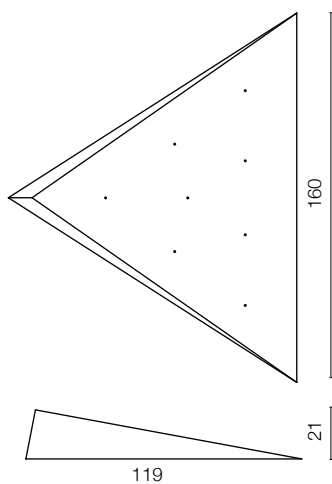

XL
8 T-Nuts

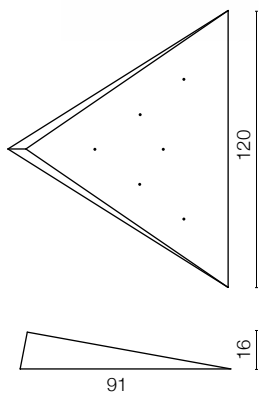

L
6 T-Nuts

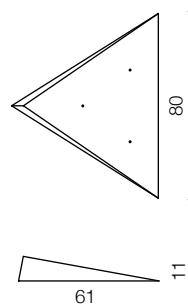

M
3 T-Nuts

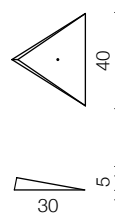

S
1 T-Nuts

// FLAT

Fresco 20°

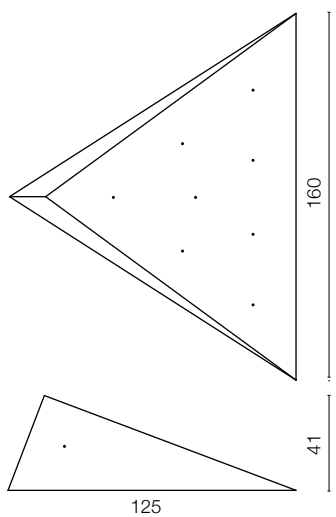

XL
10 T-Nuts

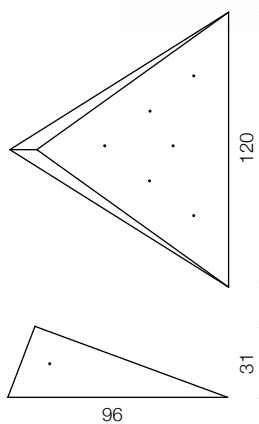

L
8 T-Nuts

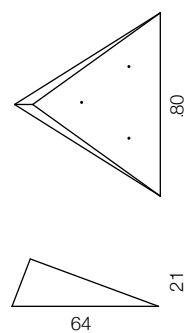

M
3 T-Nuts

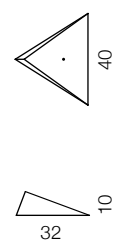

S
1 T-Nuts

Fratelli 1

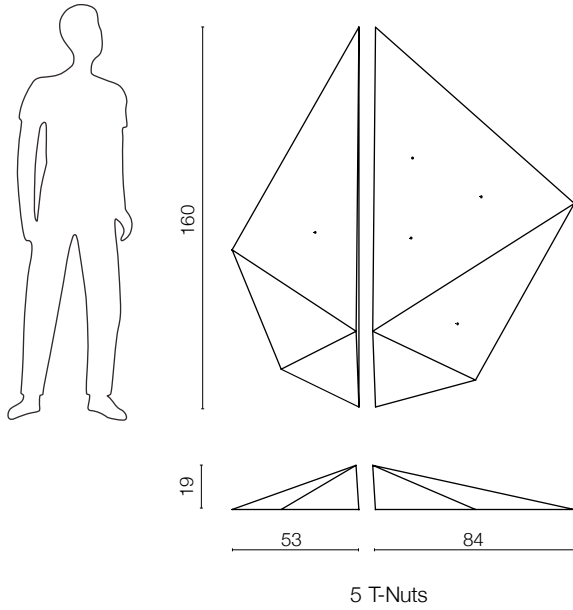

Fratelli 2

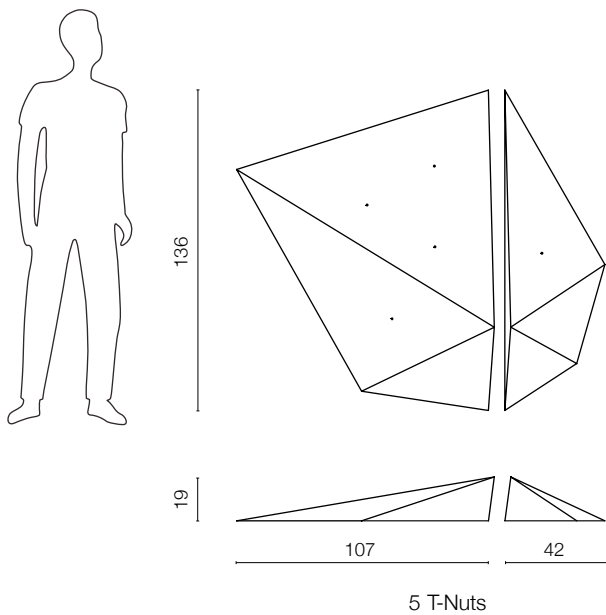



// PINCHES

Cuneo	32
Cuneo lungo	32
Asteca	33
Tufa	33
French Fries	34

Cuneo

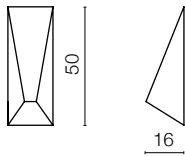
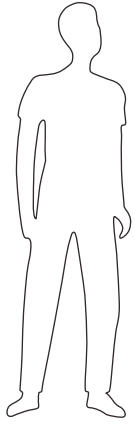

One Size

Cuneo lungo

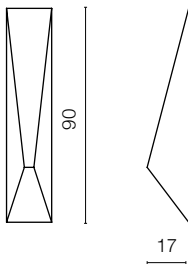
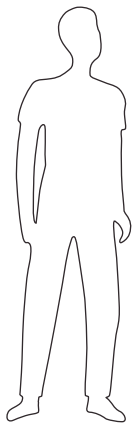

One Size

Asteca

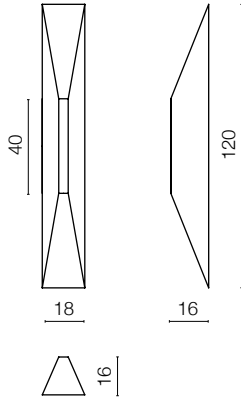
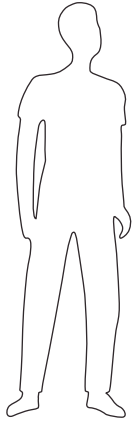

One Size



Tufa

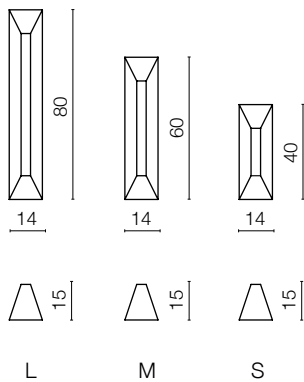
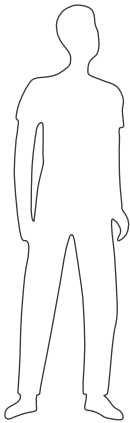

L

M

S



French Fries

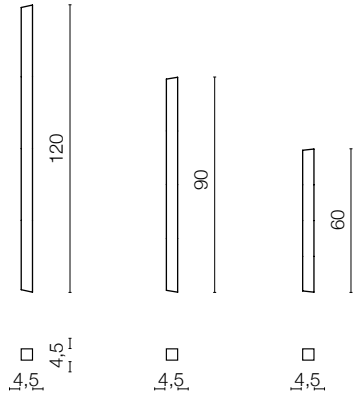
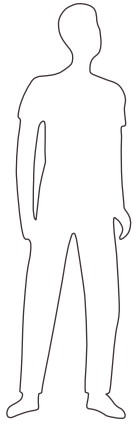



// GAMMA

Gamma 3	37
Large Gamma 3	37
Gamma 4	38

Gamma 3

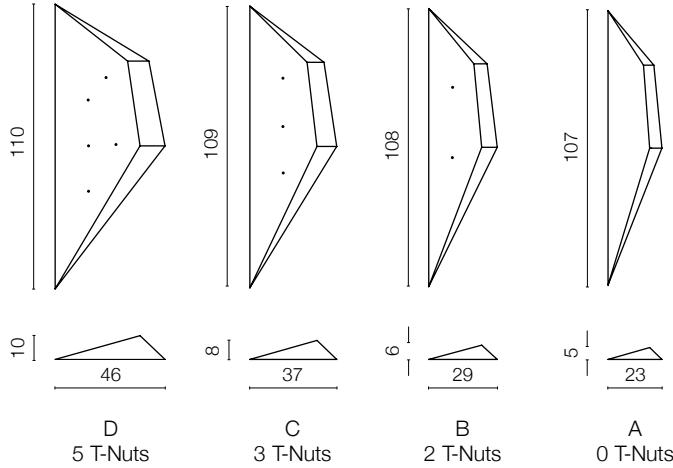
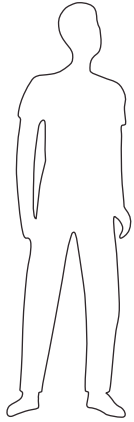

Large Gamma 3

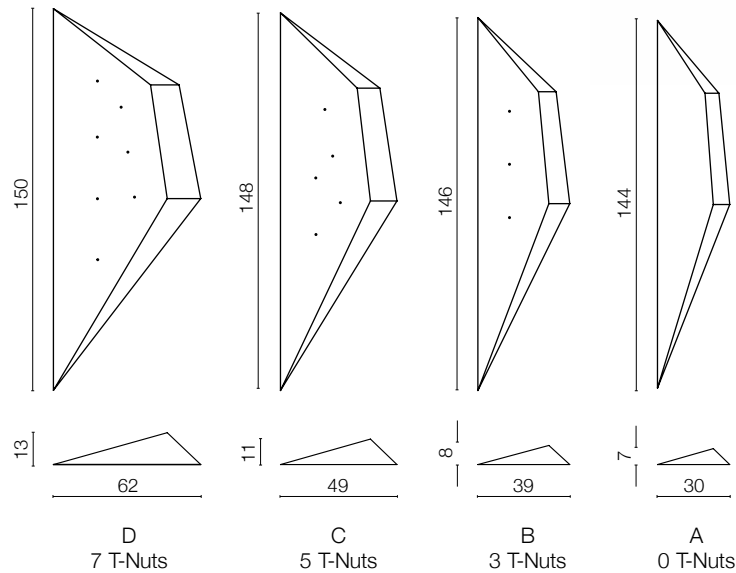
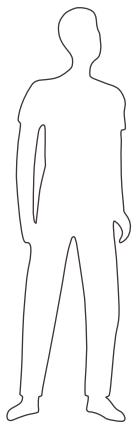

Gamma 4

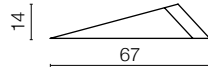
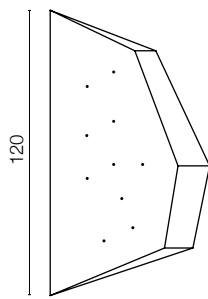
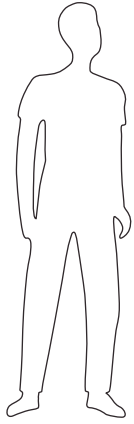

E
10 T-Nuts

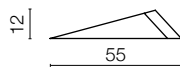
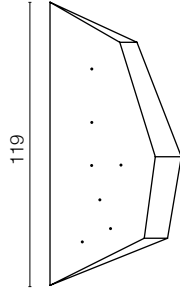

D
7 T-Nuts

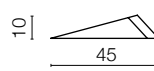
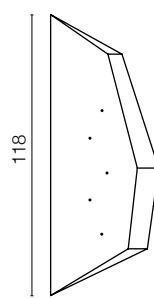

C
5 T-Nuts

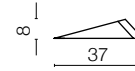
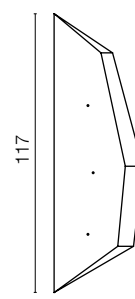

B
3 T-Nuts

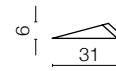
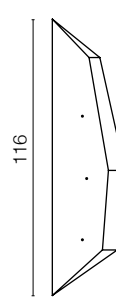

A
3 T-Nuts





Our standard colours



Ral 1023 Ral 2011 Ral 3027 Ral 5015 Ral 5018 Ral 6018 Ral 7040 Ral 9011

About our volumes... All models are made of 18 mm waterproof plywood, high-quality hardware such as Escape Climbing Industrial T-nuts, and special brass screw cup inserts, which provide a smooth assembly with less friction (screw vs. cup insert). After two years of testing, the AVA Volumes offers a special grip texture, not too aggressive but ideal for any level of climbing. All our volumes are finished with clear varnish (inside) and PU matte paint (outside). In addition to the standard colors we offer, we can produce volumes in almost any color from the RAL or NCS palette.

Handmade plywood climbing volumes

A passion for woodworking and climbing combined

foto: marcinciepielewski.pl, projekt: zychstudio.pl

AVA
VOLUMES

hello@avavolumes.com
ul. Duża 1, 05-270 Marki, Poland
+48 575 667 792 Alessandro
+48 501 603 781 Tomek